

09BMMD9632

Linear Drawing

Height (mm)	500
Light Source	96×0.14W
Selected Degree (°)θ1/2	360°
Input Voltage (V)	DC 24
Operating Current (MA)	24V=625
Consumption (W)	24V=15
Luminance (LM)	24V=1300
IK	09

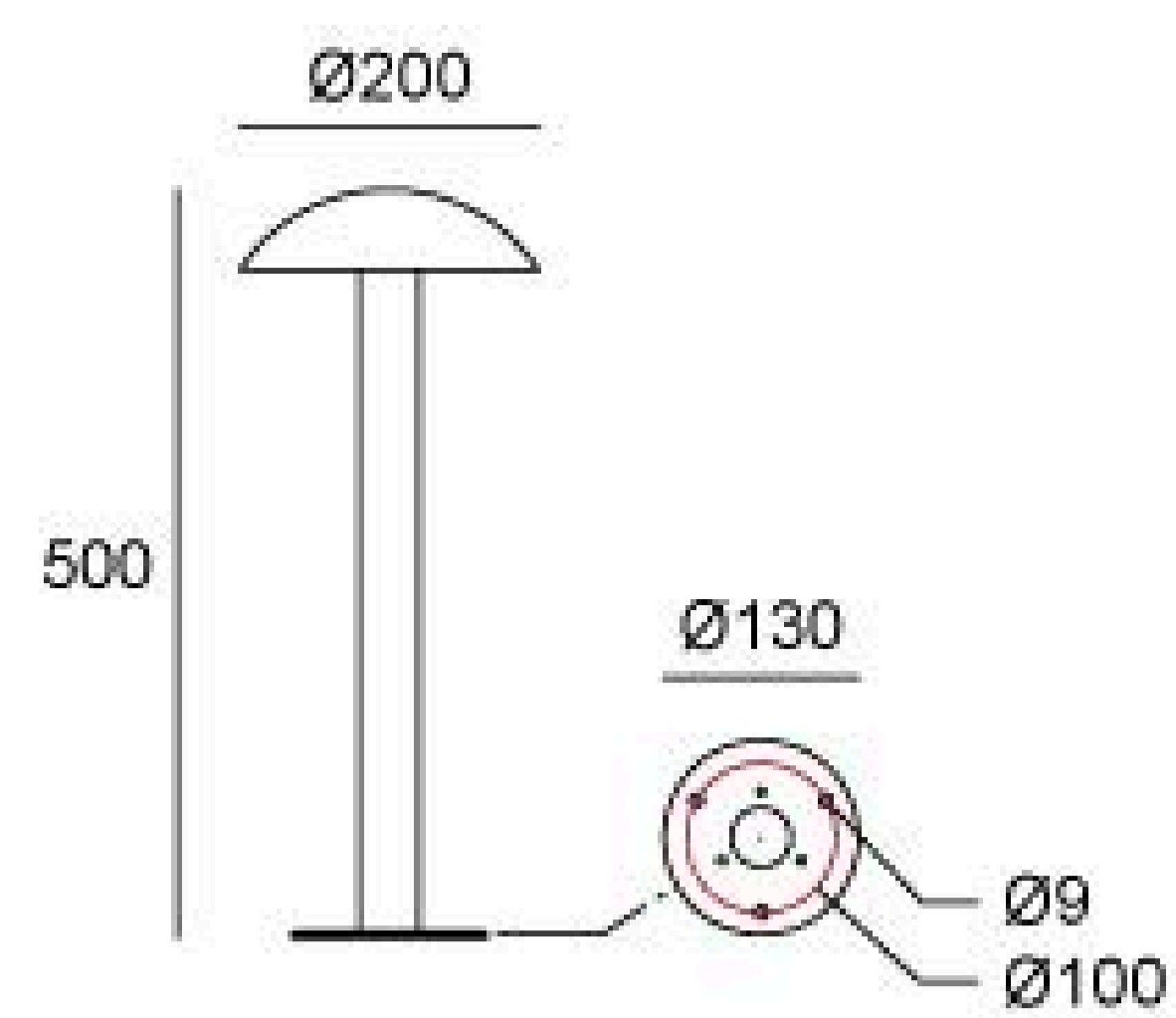

Unit: mm

Specification

Housing	12# Die-casting aluminum with powder painting. T=60-80µm. Adhesion of ISO class 1/ASTM class 4B
Light Window	UVstop & Fire Proof PC
LED Type	SMD
Gasket	Tooling shaped seal
LED Driver	Built in on/off driver
Power Cable	Outside of luminaire (Without waterstopper) H05RN-F 3×1.0mm² L=0.3m
Dimming Support	External DALI supported TRIAC,0-10V, PWM via external driver on request
Operating Temperature	-20°C~40°C

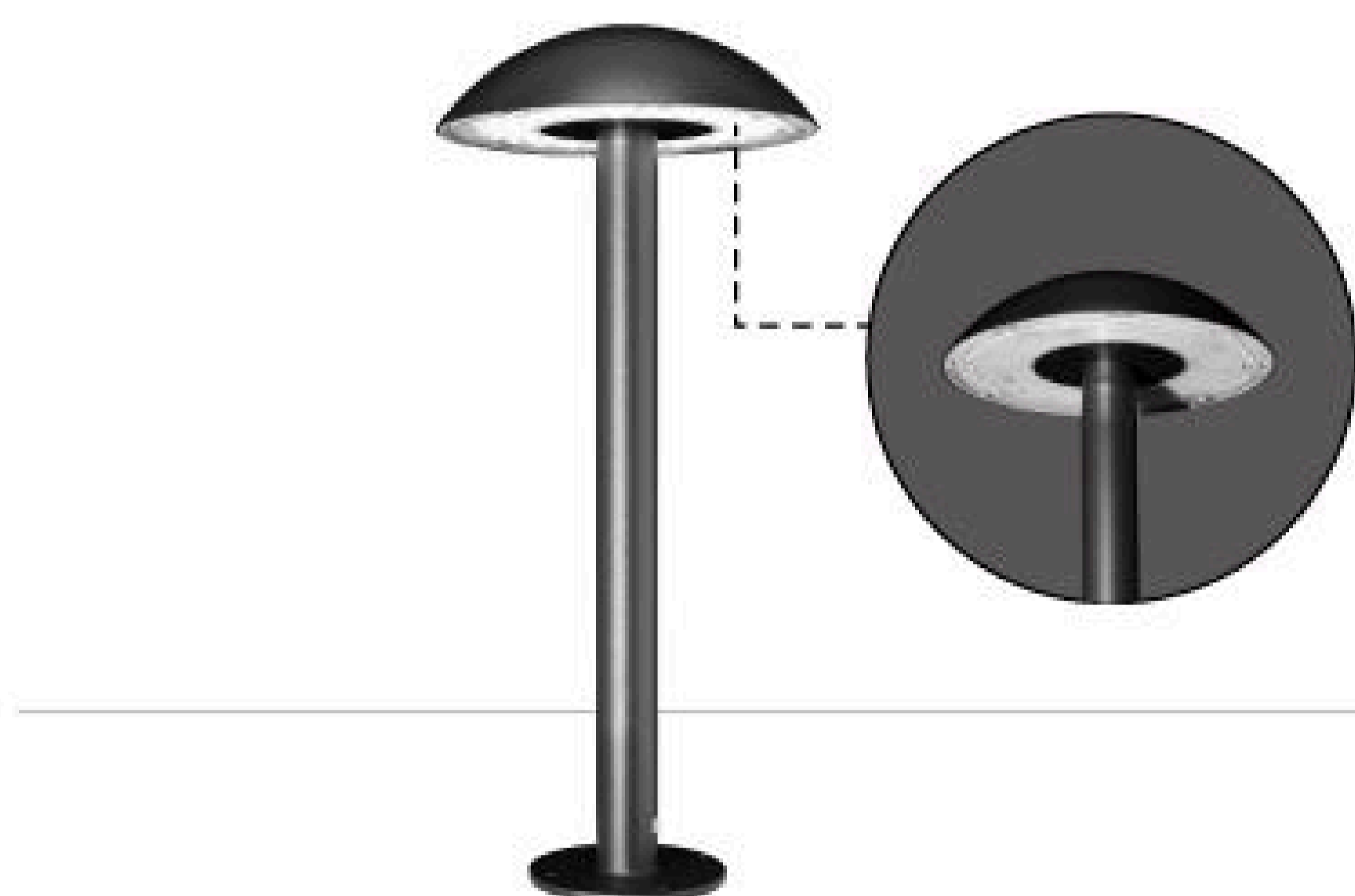

Painting Color

Primary

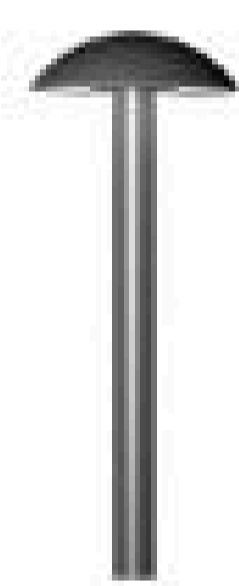

Sanded Dark Grey
KAP 7037

Secondary

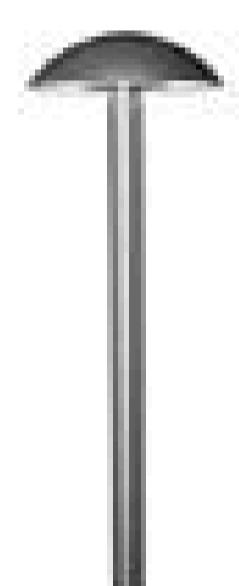

Sanded Silver Grey
KAP 9022

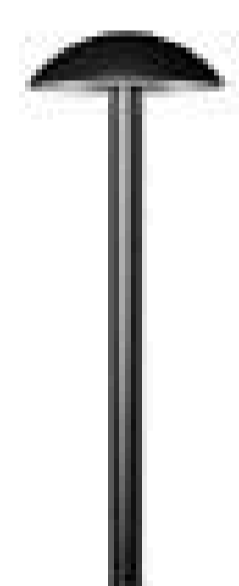

Sanded Black
RAL 9005

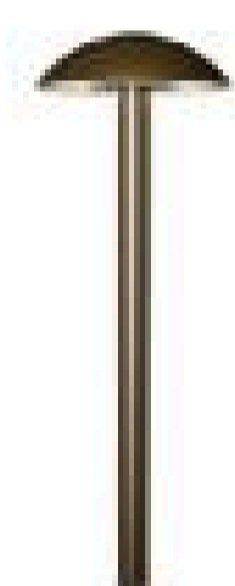

Sanded Bronze
KAP 7008

Base Options

Screw Base



A Flange Base
Non-Detachable

Inground Base (Optional)



JC3002

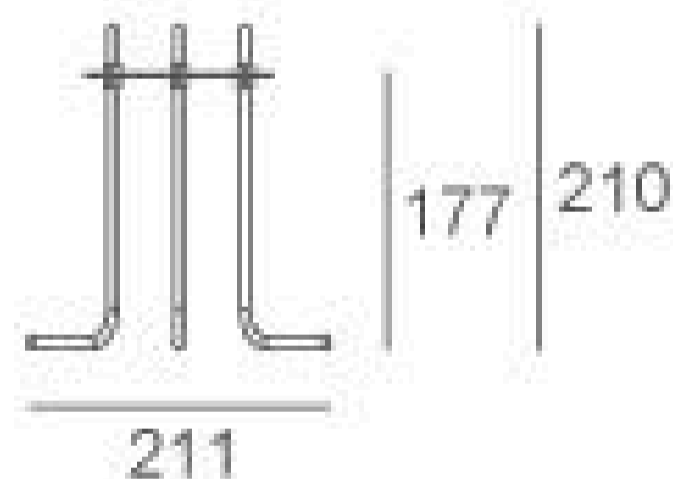
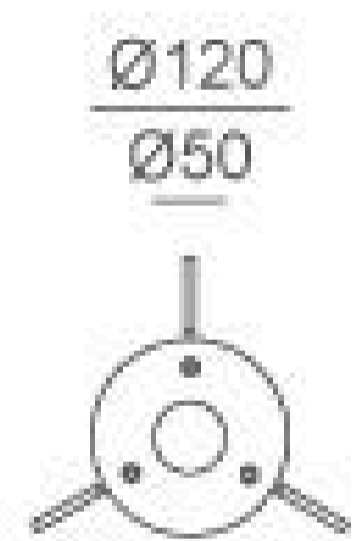

Ground Anchor Base (Optional)

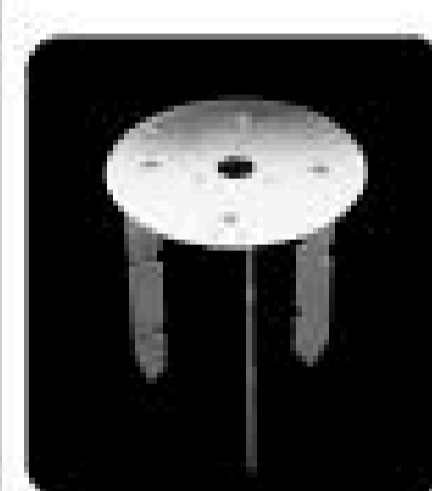

20A

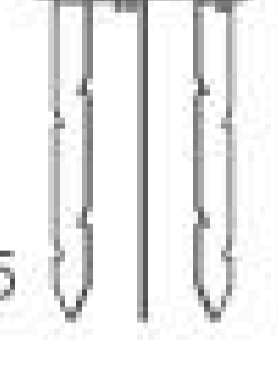

Installation steps
(Optional)

